

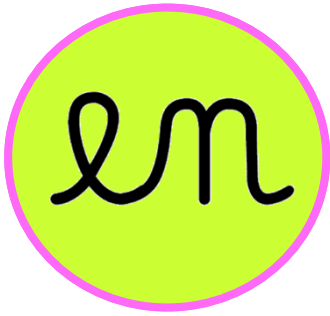

mor**a**ngo

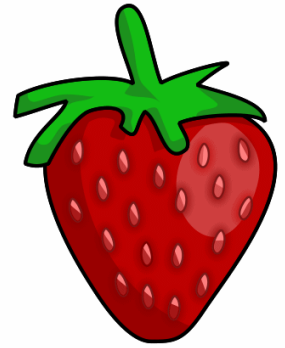

de**e**nte



ti**i**nta



fo**o**nte

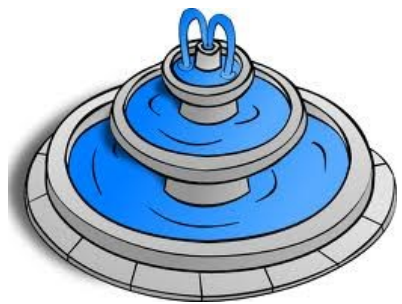

mu**m**do



an

mor**an**go



en

den**e**



in

tin**ta**



on

font**e**



un

mun**do**



an

mor**an**go



en

den**e**



in

tin**ta**



on

font**e**



un

mun**do**



an

mor**an**go



en

den**e**



in

tin**ta**



on

font**e**



un

mun**do**



an

mor**an**go



en

den**e**



in

tin**ta**



on

font**e**



un

mun**do**



an

mor**an**go



en

den**e**



in

tin**ta**



on

font**e**



un

mun**do**



an

mor**an**go



en

den**e**



in

tin**ta**



on

font**e**



un

mun**do**



an

mor**an**go



en

den**e**



in

tin**ta**



on

font**e**



un

mun**do**



an

mor**an**go



en

den**e**



in

tin**ta**



on

font**e**



un

mun**do**



an

mor**an**go



en

den**e**



in

tin**ta**



on

font**e**



un

mun**do**



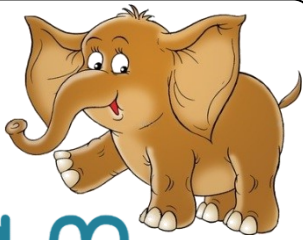

an

elefante



an

elefante



an

elefante

en



pente

en



pente

en



pente

pinto



in

pinto



in

pinto



in

concha



on

concha



on

concha



on

un



mundo

un



mundo

un

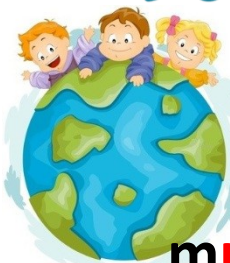

mundo



l**aran**ja

t**en**da



p**in**cel

onda



m**un**do



an en in on un

an en in on un

banco	lenço
anjo	pinto
laranja	pincel
morango	tinta
elefante	índio
tanque	fonte
pente	onda
dente	fundo
avental	mundo

an en in on un

an en in on un

banco	lenço
anjo	pinto
laranja	pincel
morango	tinta
elefante	índio
tanque	fonte
pente	onda
dente	fundo
avental	mundo

an en in on un

an en in on un

banco	lenço
anjo	pinto
laranja	pincel
morango	tinta
elefante	índio
tanque	fonte
pente	onda
dente	fundo
avental	mundo

an en in on un

an en in on un

banco	lenço
anjo	pinto
laranja	pincel
morango	tinta
elefante	índio
tanque	fonte
pente	onda
dente	fundo
avental	mundo



Pinta e recorta as imagens e as palavras.

Cola-as corretamente no teu cadernão.

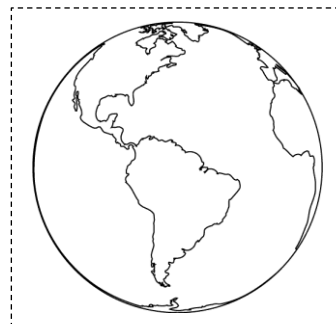
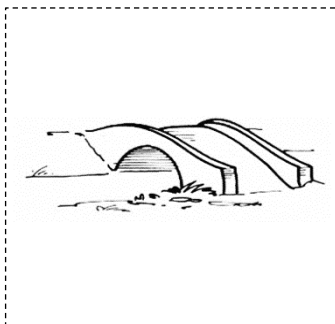
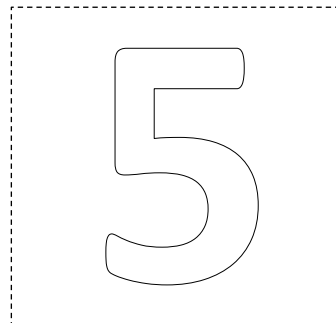
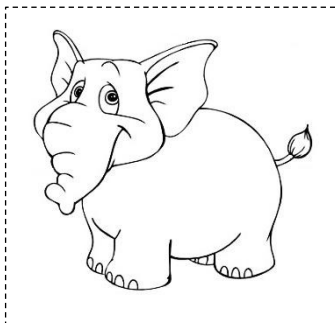
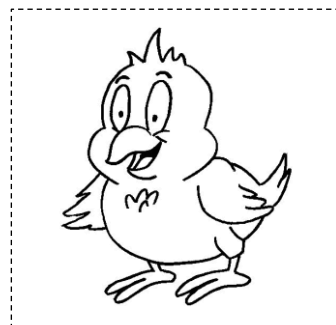
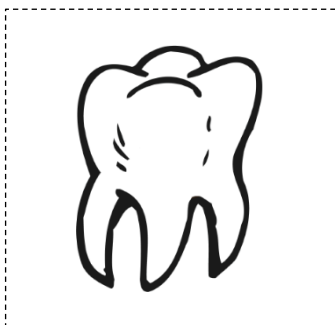
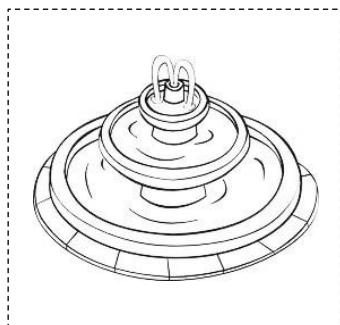

cinco

pinto

índio

ponte

pente

elefante

dente

fonte

tinta

anzol

mundo

tanque