

Nome : \_\_\_\_\_

INFORMAÇÃO : \_\_\_\_\_

Data : \_\_\_/\_\_\_/\_\_\_



Eu sou a letra que se lê **ja, je, ji, jo, ju**. Completa.

j

ja je ji jo ju

J

Ja Je Ji Jo Ju

Nome : \_\_\_\_\_

INFORMAÇÃO : \_\_\_\_\_

Data : \_\_\_\_ / \_\_\_\_ / \_\_\_\_

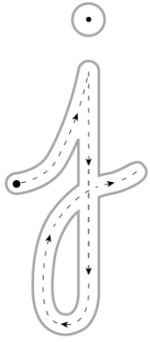

É o **j**ipe.  
É o **j**ipe.



É o **J**aime.  
É o **J**aime.



 **Copia.**

**j** j \_\_\_\_\_  
**ja** ja \_\_\_\_\_  
**je** je \_\_\_\_\_  
**ji** ji \_\_\_\_\_  
**jo** jo \_\_\_\_\_  
**ju** ju \_\_\_\_\_

**J** J \_\_\_\_\_  
**Ja** Ja \_\_\_\_\_  
**Je** Je \_\_\_\_\_  
**Ji** Ji \_\_\_\_\_  
**Jo** Jo \_\_\_\_\_  
**Ju** Ju \_\_\_\_\_

 **Completa conforme o exemplo.**

pi	ja	ne	no	ji	ta	la	ma	pe
	x		x		x			

janota \_\_\_\_\_  
 \_\_\_\_\_  
 \_\_\_\_\_  
 \_\_\_\_\_

 **Ordena as palavras e forma as frases.**

João à O loja vai jipe. no

vê jibóia O na Jaime a jaula.

Nome : \_\_\_\_\_

INFORMAÇÃO : \_\_\_\_\_

Data : \_\_\_\_ / \_\_\_\_ / \_\_\_\_



jibóia

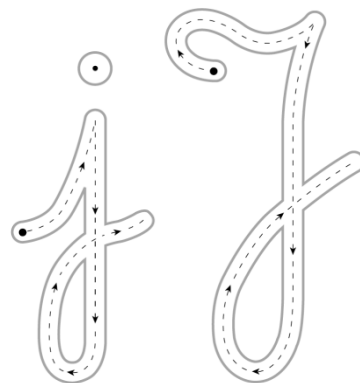

Continua a letra **j**.

j

j



Escreve os nomes.

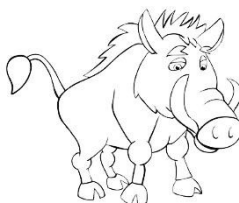
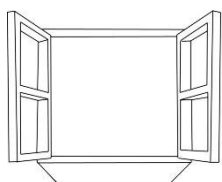

Continua a letra **J**.

J

J



Forma frases com as palavras.

Judite javali ► \_\_\_\_\_

janela Joana ► \_\_\_\_\_

jipe Jaime ► \_\_\_\_\_

jaula jibóia ► \_\_\_\_\_

Nome : \_\_\_\_\_

INFORMAÇÃO : \_\_\_\_\_

Data : \_\_\_\_ / \_\_\_\_ / \_\_\_\_



Separa as sílabas.

jogo



tijolo

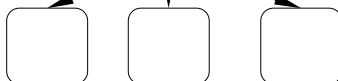

jipe



Joana

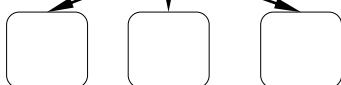

javali

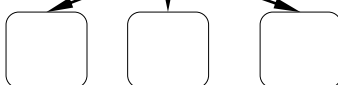

jibóia

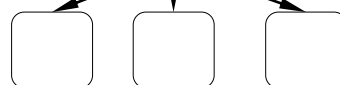

Escreve uma frase com as palavras.

bola Júlio na rua. O joga à

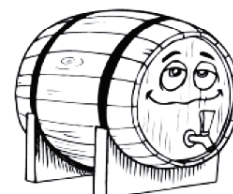
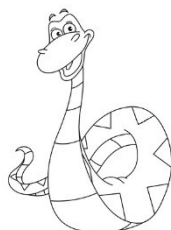
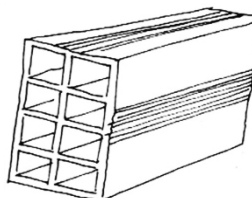
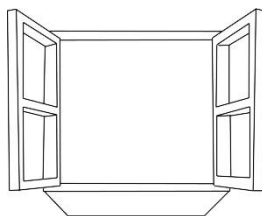
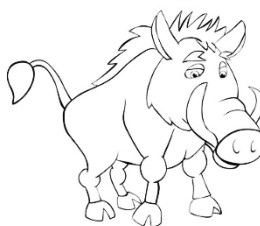
Pinta as figuras em cujos nomes ouves **j**.

Nome : \_\_\_\_\_

INFORMAÇÃO : \_\_\_\_\_

Data : \_\_\_\_ / \_\_\_\_ / \_\_\_\_

 Completa com as sílabas correctas. Observa o exemplo.

pi ja ma ▶	la	ga	<del>ja</del>	ta
reale _____ ▶	so	jo	go	mo
bati _____ ▶	ga	ba	ma	ja
_____ pe ▶	li	ji	ti	ni
_____ doca ▶	gu	su	ju	tu



 Completa as frases com uma das palavras.



jóia



botija



jipe

A Júlia leva o  \_\_\_\_\_ do pai.



jogo



janela



pijama

O meu  \_\_\_\_\_ é muito bonito.



janota



jaula



jibóia

Eu vejo o leão na  \_\_\_\_\_ do javali.

Nome : \_\_\_\_\_

INFORMAÇÃO : \_\_\_\_\_

Data : \_\_\_\_ / \_\_\_\_ / \_\_\_\_

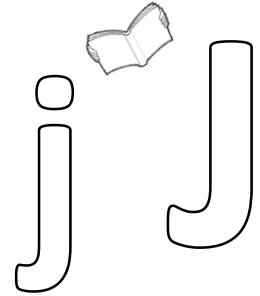
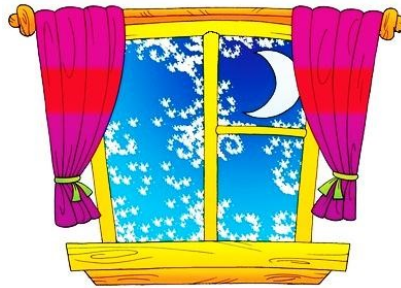
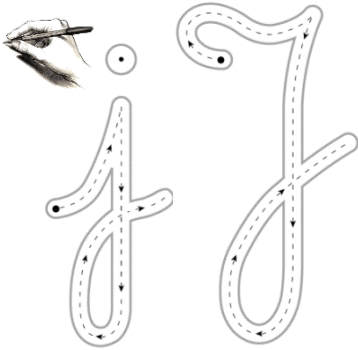
É a **j**anela.
 Escreve.

j  
J

ja

je

ji

jo

ju

Ja

Je

Ji

Jo

Ju

jaula

laje

jibóia

jogo

judoca

 Circunda os **j j J J**

javali

tijolo

Júlio

Joana

janela

jipe

Jaime

pijama

jaula

cajado

jibóia

loja

jogo

judo

já

janota

beijo

jota

ajuda

sujo

jóia

juba

judeu

Juca



 Assinala com **X** as figuras em cujos nomes ouves **j**.









 **Escreve as frases completas:**

O  saiu da  .

---

O  caiu da  .

---

 **Faz a correspondência e escreve as palavras:**

janela •  → \_\_\_\_\_

tijolo •  → \_\_\_\_\_

jóia •  → \_\_\_\_\_

pijama •  → \_\_\_\_\_

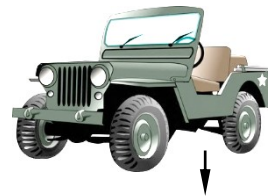

 **Copia as frases:**

O meu pijama é bonito e janota.

---

O Júlio pega no tijolo e coloca-o no jipe.

---

O javali vive na jaula.

---



A Joana ajuda o pai na loja.

Pela janela da loja vê a jibóia na jaula.

A jibóia vive na mata e é bonita.

Nome : \_\_\_\_\_

INFORMAÇÃO : \_\_\_\_\_

Data : \_\_\_\_ / \_\_\_\_ / \_\_\_\_

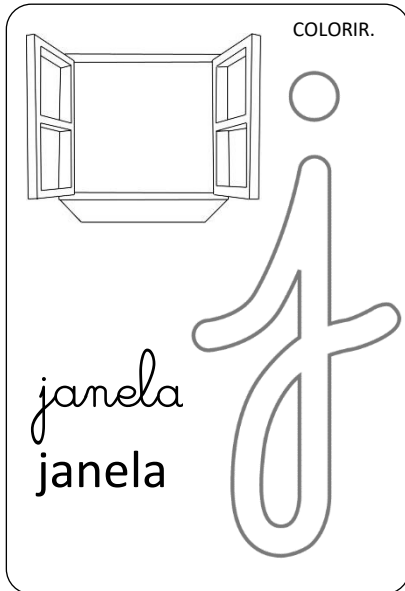

j j \_\_\_\_\_  
 ja ja \_\_\_\_\_  
 je je \_\_\_\_\_  
 ji ji \_\_\_\_\_  
 jo jo \_\_\_\_\_  
 ju ju \_\_\_\_\_

 Lê, copia e ilustra.

O Juca vai à janela e vê a Joana.

- Olá, Joana!
- Viva, Juca!
- A tua mana vai comigo ao judo?
- Não sei se vai, Juca. Logo ligo-te.

---



---



---



---

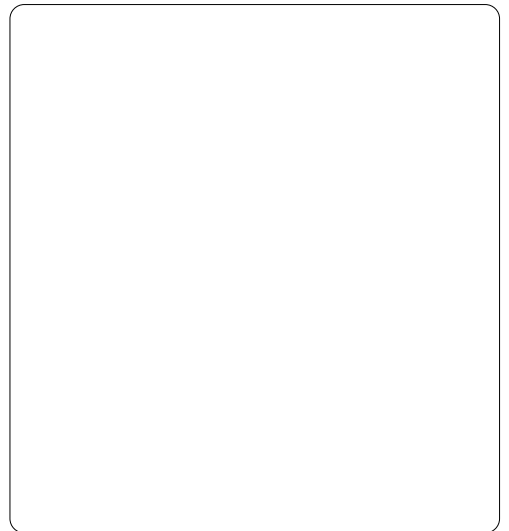

 Completa de acordo com o texto.

Da janela o \_\_\_\_\_ vê a \_\_\_\_\_.

O \_\_\_\_\_ vai ao judo.

A Joana não sabe se a sua \_\_\_\_\_ vai.



Nome : \_\_\_\_\_

INFORMAÇÃO : \_\_\_\_\_

Data : \_\_\_\_ / \_\_\_\_ / \_\_\_\_



J \_\_\_\_\_  
 Ja \_\_\_\_\_  
 Je \_\_\_\_\_  
 Ji \_\_\_\_\_  
 Jo \_\_\_\_\_  
 Ju \_\_\_\_\_

Lê e copia.

O pai da Juliana levou-a ao jogo da bola.  
 No jogo, o Jaime caiu.  
 O seu amigo João ajudou-o.  
 O Jaime, todo sujo, riu muito.



---



---



---



---

Escreve os seus nomes e pinta.

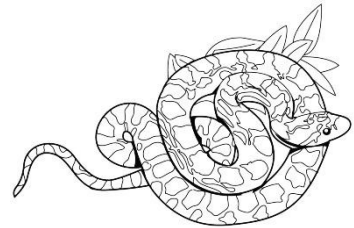
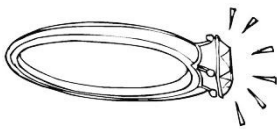

---



---



---

Nome : \_\_\_\_\_

INFORMAÇÃO : \_\_\_\_\_



Data : \_\_\_\_ / \_\_\_\_ / \_\_\_\_

É o João. Ele é judoca.



**Escreve as frases completas.**

O  leva o  ao avô.

A Joana vê a  do leão pela .

A Júlia levou o  da  da tia Rita.

O  deu a  à mãe.

**Ordena as palavras e escreve a frase.**

vi javali Eu o mata. na \_\_\_\_\_ janela. à Joana A vai \_\_\_\_\_

Nome : \_\_\_\_\_

INFORMAÇÃO : \_\_\_\_\_

Data : \_\_\_\_ / \_\_\_\_ / \_\_\_\_

O Jaime deu o beijo à Joana.





 Escreve as frases completas.

A  vai à  e vê o .

---

O tio Júlio leva uma  da .

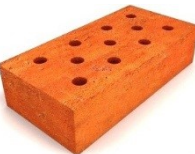
---

O pai do Jaime leva o  no .

---

O Romeu tocou o  e a  saiu da toca.

---

 Ordena as palavras e escreve a frase.

janela. O da Juca joga viu o      leão O vive jaula. na

---

Nome : \_\_\_\_\_

INFORMAÇÃO : \_\_\_\_\_

Data : \_\_\_\_ / \_\_\_\_ / \_\_\_\_



Inventa uma frase para cada gravura.

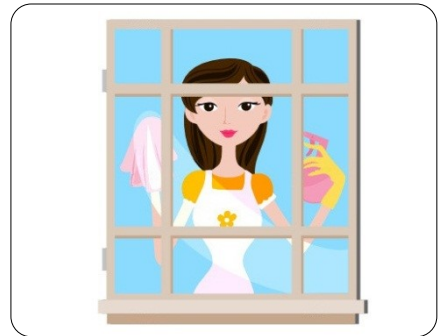

Nome : \_\_\_\_\_

INFORMAÇÃO : \_\_\_\_\_

Data : \_\_\_\_ / \_\_\_\_ / \_\_\_\_



Escreve as palavras que correspondem às imagens. Pinta.

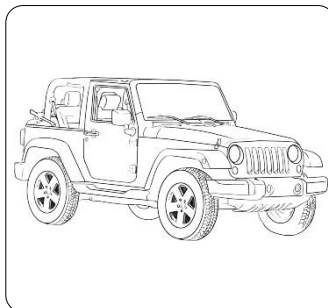
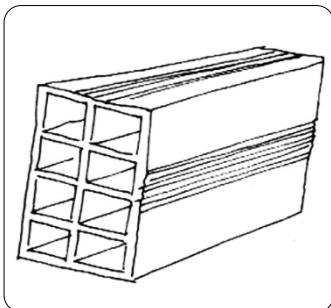
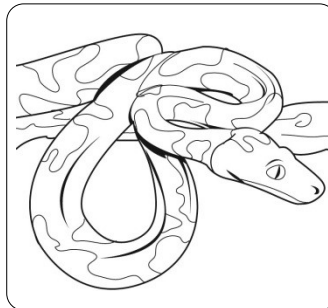
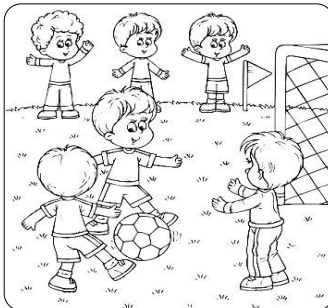
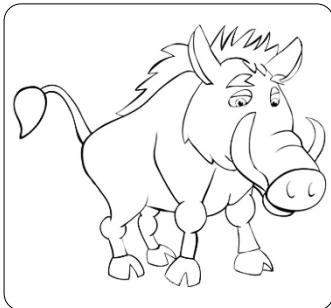
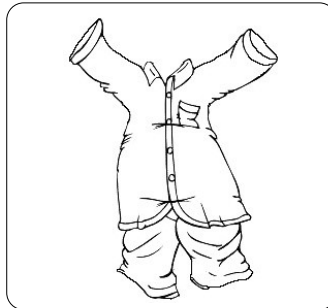
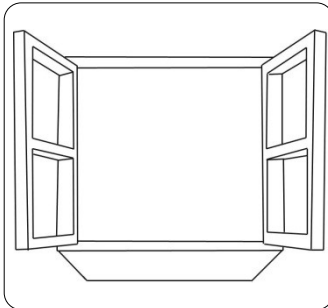
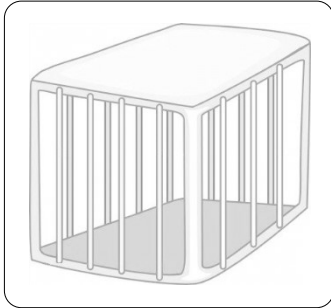

janela

javali

jibóia

judo

tijolo

jipe

pijama

jaula

loja

jogo

jóia

juba

Nome : \_\_\_\_\_

INFORMAÇÃO :

Data : \_\_\_\_ / \_\_\_\_ / \_\_\_\_



Lê as palavras. Escreve a que está de acordo com a figura.

beijo **ou** jogo?



É a \_\_\_\_\_.

jipe **ou** judo?



É a \_\_\_\_\_.

jibóia **ou** jóia?

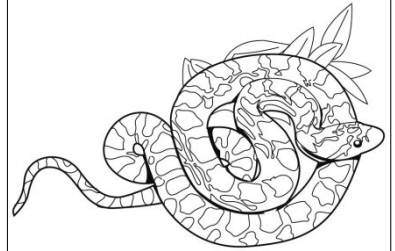

É a \_\_\_\_\_.

pijama **ou** realejo?

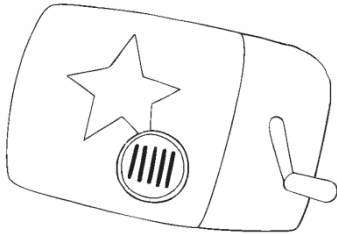

É a \_\_\_\_\_.

jóia **ou** jaula?



É a \_\_\_\_\_.

javali **ou** tijolo?

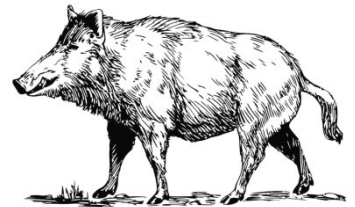

É a \_\_\_\_\_.



Lê as palavras e faz os desenhos.

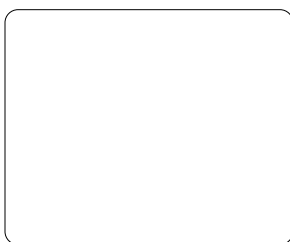

janela

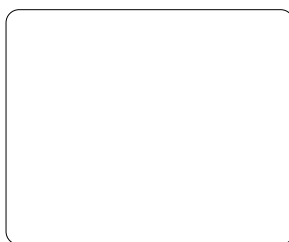

botija

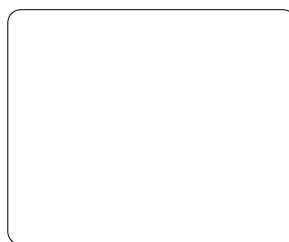

jipe

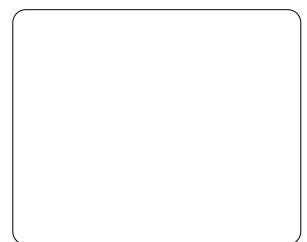

tijolo



cajado



jaula



loja



jogo

Nome : \_\_\_\_\_

INFORMAÇÃO : \_\_\_\_\_

Data : \_\_\_\_ / \_\_\_\_ / \_\_\_\_



Junta as sílabas e forma a palavra que está de acordo com a imagem.

pe



ji

\_\_\_\_\_

ti



ja

bo

\_\_\_\_\_

lo



ja

\_\_\_\_\_

ja

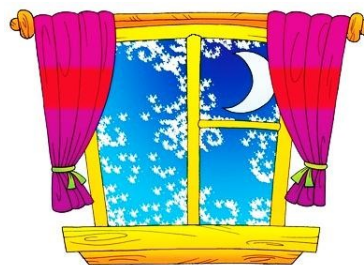

ne

la

\_\_\_\_\_

ba



ju

\_\_\_\_\_

li

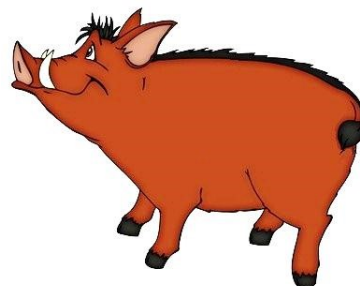

va

ja

\_\_\_\_\_

go



jo

\_\_\_\_\_

ja

ca

do



\_\_\_\_\_

Nome : \_\_\_\_\_

INFORMAÇÃO : \_\_\_\_\_

Data : \_\_\_\_ / \_\_\_\_ / \_\_\_\_



Descobre palavras com **ja, je, ji, jo, ju.**

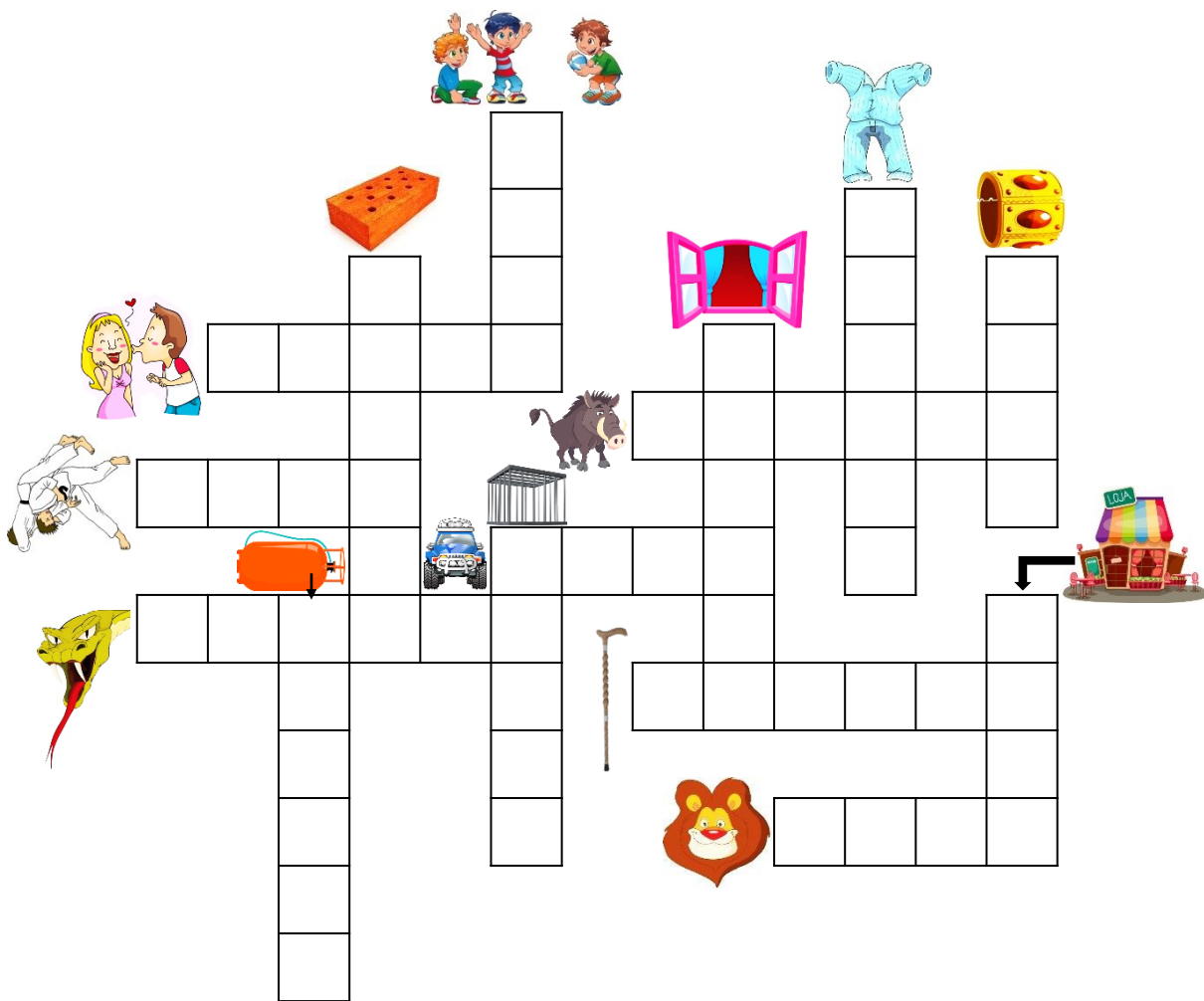

Escreve as palavras que descobriste.



\_\_\_\_\_

\_\_\_\_\_

\_\_\_\_\_

\_\_\_\_\_

\_\_\_\_\_





Nome : \_\_\_\_\_

INFORMAÇÃO : \_\_\_\_\_

Data : \_\_\_/\_\_\_/\_\_\_



Lê e escreve este pequeno texto.  
Pinta o desenho a teu gosto.

## O Jaime e o jipe

Eu vejo da janela o jogo da bola.  
O meu amigo Jaime joga todo janota.  
Ele levou no jipe até ao jogo, a sua amiga  
Joana.



---

---

---

---

---

---

---

---

---

---

---

---

